

## Position Switches Series 7070



11342E00

- > Dimensions and characteristic values according to EN 50041
- > Replaceable contact
- > Positive opening contacts
- > Category 1 safety position switch with a variable system of actuators
- > All inserts may be displaced by 4 x 90°
- > Contacts with:
  - Snap-action contact
  - Slow-action contact
  - Make before break slow-action contact
- > Possible as version with unconnected cable end



Position switches are used to monitor the position of moving parts of machines and systems.

They can be used in safety circuits as the device satisfies the standard EN 60947-5-1 (VDE 0660 Part 200) and the normally closed contacts are positive opening contacts.

The switching element and the actuating element of category 1 safety switches form a constructional and functional unit.









As a result of the galvanic isolation of the moving contacts, the position switch is suitable for switching various potentials.

	ATEX					
Zone	0	1	2	20	21	22
For use in					x	x

## Position Switches

### Series 7070

Selection Table

Version	Actuator		Order number	Weight kg
 03788E00	Extended plunger	Plunger of stainless steel	<b>7070/1-.-S</b>	0.155
 03789E00	Roller plunger	Roller of moulded material	<b>7070/1-.-RS</b>	0.154
 04550E00	Roller lever, form E (can be modified into an angled roller lever)	Roller of moulded material	<b>7070/1-.-AR</b>	0.155
 03790E00	Swivelling roller lever, form A	Roller of moulded material; for minimum force 0.3 Nm	<b>7070/1-.-HR311</b>	0.221
 03790E00	Swivelling roller lever, form A (swivelling lever of stainless steel)	Roller of moulded material; for minimum force 0.1 Nm	<b>7070/1-.-HR311NR</b>	0.221
 04551E00	Adjustable roller lever	Roller of moulded material; Roller rod of stainless steel	<b>7070/1-.-HV</b>	0.269
 09380E00	Actuating rod	Rod of moulded material  <b>No positive opening, not suitable for safety circuits!</b>	<b>7070/1-.-HH-K</b>	0.237
 04552E00	Spring-rod actuator	Spring of stainless steel  Only for use with snap-action contact! <b>No positive opening, not suitable for safety circuits!</b>	<b>7070/1-2-F2</b>	0.234
 04553E00	Safety switch	Separate actuator of moulded material	<b>7070/1-1-ZB</b>	0.268

#### Order Number Supplement

Switching function	1 NC + 1 NO	Slow-action contact	<b>7070/1-1-...</b>
	2 NC	Slow-action contact	<b>7070/1-3-...</b>
	2 NO	Slow-action contact	<b>7070/1-4-...</b>
	1 NC + 1 NO	Slow-action contact, make before break	<b>7070/1-5-...</b>
	1 NC + 1 NO	Snap-action contact, with spring	<b>7070/1-2-...</b>
		Version with unconnected cable end	<b>7070/1-.....-K</b>

Note The actuators enclosed are not mounted

# Position Switches

## Series 7070



### Explosion Protection

#### Marking

Europe (ATEX) Dust explosion protection	II 2 D Ex tD A21 IP65 T80°C
--	-----------------------------

#### Certificates

Europe (ATEX) Dust explosion protection	PTB 06 ATEX 1020
--	------------------

### Technical Data

#### Electrical data

Rated operational voltage $U_e$	7070/1-1 7070/1-2 7070/1-5		7070/1-3 7070/1-4	
	Alternating current for equal potential: max. 500 V		max. 400 V	
	Alternating current for unequal potential: max. 250 V		max. 250 V	
	Direct current: 250 V		250 V	
Rated operational current $I_e$	max. 10 A: $-20\text{ °C} \leq T_a \leq +50\text{ °C}$ max. 6 A: $-20\text{ °C} \leq T_a \leq +70\text{ °C}$			
Switching capacity	AC-12 7070/1-1 7070/1-2 7070/1-5		AC-15 7070/1-1 7070/1-2 7070/1-5	
	max. 250 V max. 500 V **) max. 10 A max. 5000 VA		max. 250 V max. 400 V **) max. 10 A max. 4000 VA	
	max. 250 V max. 500 V **) max. 10 A max. 5000 VA		max. 250 V max. 400 V **) max. 10 A max. 1000 VA	
	max. 125 V max. 10 A max. 400 W			
	**) Only for equal potential			
Rated insulation voltage	550 V			
Rated impulse withstand voltage	6 kV			
Short circuit protection	10 A gG			

#### Ambient conditions

Operating temperature range	-20 ... +50 °C (10 A) -20 ... +70 °C (6 A)
-----------------------------	---

#### Mechanical data

Mechanical shock resistance	Snap-action contact: 2 g Slow-action contact: 20 g
Degree of protection	IP65
Enclosure material	Polyamide, glass fibre reinforced, black
maximum switching frequency	max. 6000 operations/h

#### Mounting / Installation

Cable glands	8161/5-M20-13 On the enclosure bottom: 1 x M20 x 1.5 On the enclosure side: 1 x M20 x 1.5
Terminals	1 x 2.5 mm <sup>2</sup> or 2 x 1 mm <sup>2</sup> , single-wire / finely-stranded
Connection	With cable glands 8161: For plastic sheathed cable 4 x 2.5 mm <sup>2</sup> (diameter 6 ... 13 mm); recommended 4 x 1.5 mm <sup>2</sup> With mounted connecting cable: Plastic sheathed cable HK-SO-X05VV-F-OZ 4 x 1.5 mm, cable length 6 m
Tightening torque	Screw terminals: max. 0.4 Nm Cover screws: max. 0.7 Nm Connection thread: 2.3 Nm (M20 x 1.5) Pressure screw: 1.5 Nm (M20 x 1.5)

E4

# Position Switches

## Series 7070

### Technical Data

#### Contact

Version

Slow-action contact

Snap-action contact

Slow-action contact, make before break

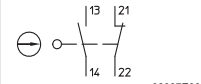

7070/1-1 08667E00

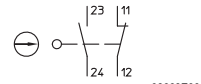

7070/1-2 08668E00

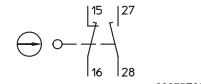

7070/1-5 08675E00

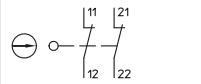

7070/1-3 08669E00

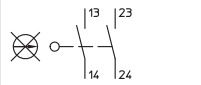

7070/1-4 08670E00

Attention:  
The positive opening function ⊕ depends on the actuator used

Contact arrangement  
Contact opening  
Service life  
    mechanical  
    electrical  
Material  
    Contacts  
    Enclosure contact

2-pole, galvanically isolated, with double break action  
≥ 1.5 mm (isolating distance ≥ 3 mm)  
max. 10<sup>6</sup> operations  
max. 10<sup>6</sup> operations  
Silver-nickel  
Polyamide, glass fibre reinforced

### Operation, Operating Speed, Contact Travel or Angle





Actuator	Operation	Diagram	Nominal contact travels or angles	Minimum force/torque
Type 7070/1	V = Max. operating speed → = Direction of operation ( ) = Connection for device with unconnected cable end	⊕ = Positive opening	■ = Contact closed □ = Contact open Zw = Travel for positive opening	
Extended plunger 7070/1- . . S	<p>Lateral operation: V = 0.5 m/s</p> <p>Operation in stroke direction: V = 0.5 m/s</p>		<p>In stroke direction</p> <p><b>7070/1-1:</b></p> <p><b>7070/1-2:</b></p> <p><b>7070/1-3:</b></p> <p><b>7070/1-4:</b></p> <p><b>7070/1-5:</b></p>	15 N

# Position Switches

## Series 7070

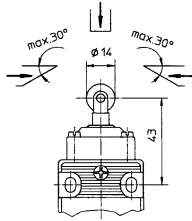
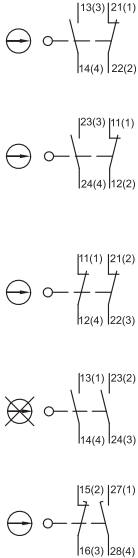
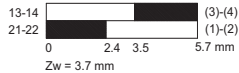

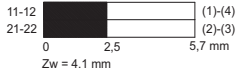
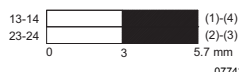
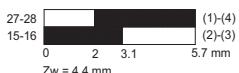
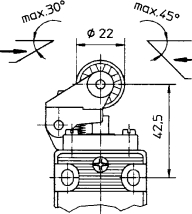
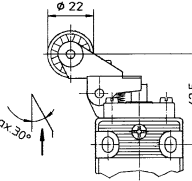
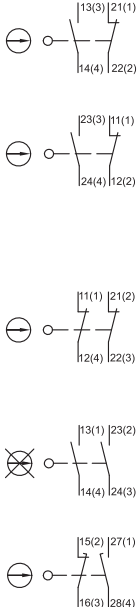
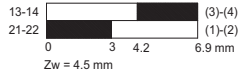
### Operation, Operating Speed, Contact Travel or Angle

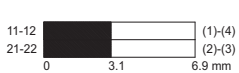
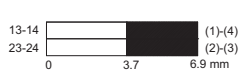
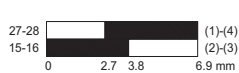

Actuator	Operation	Diagram	Nominal contact travels or angles	Minimum force/torque
Type 7070/1	<p>V = Max. operating speed            → = Direction of operation            () = Connection for device witch un-connected cable end</p>	<p>⊕ = Positive opening</p>	<p>■ = Contact closed            □ = Contact open            Zw = Travel for positive opening</p>	
Roller plunger 7070/1- . -RS	 <p>08097E00</p> <p>Lateral operation: V = 0.5 m/s</p> <p>Operation in stroke direction: V = 0.5 m/s</p>	 <p>07695E00</p> <p>07696E00</p> <p>07697E00</p> <p>07698E00</p> <p>07699E00</p>	<p>In stroke direction</p> <p><b>7070/1-1:</b></p>  <p>07731E01</p> <p><b>7070/1-2:</b></p>  <p>07752E01</p> <p><b>7070/1-3:</b></p>  <p>07742E01</p> <p><b>7070/1-4:</b></p>  <p>07743E01</p> <p><b>7070/1-5:</b></p>  <p>07730E01</p>	15 N
Roller lever plunger, form E 7070/1- . -AR	 <p>08098E00</p> <p>V = 1.5 m/s</p> <p>Angled roller lever, form E: modified version of 7070/1- . -AR</p>  <p>08665E00</p> <p>Angled roller lever made by rotating the roller lever plunger by 180°</p>	 <p>07695E00</p> <p>07696E00</p> <p>07697E00</p> <p>07698E00</p> <p>07699E00</p>	<p>Movement of the roller in stroke direction of the plunger after plunger starts moving</p> <p><b>7070/1-1:</b></p>  <p>07732E01</p> <p><b>7070/1-2:</b></p>  <p>07750E01</p> <p><b>7070/1-3:</b></p>  <p>07744E01</p> <p><b>7070/1-4:</b></p>  <p>07745E01</p> <p><b>7070/1-5:</b></p>  <p>07733E01</p>	13 N

E4

# Position Switches

## Series 7070

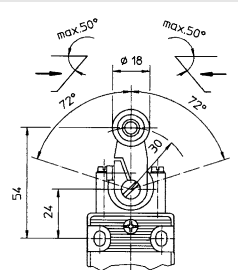
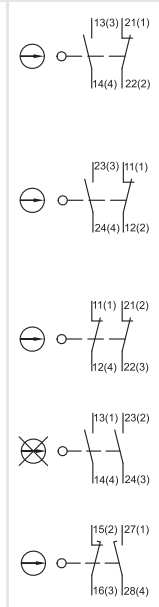
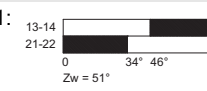
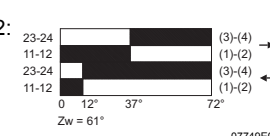
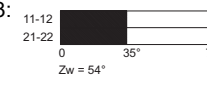
### Operation, Operating Speed, Contact Travel or Angle

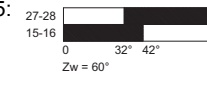
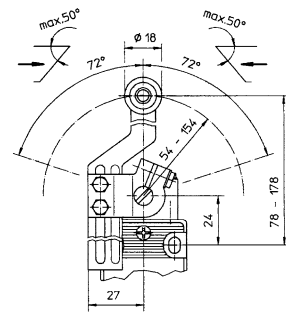
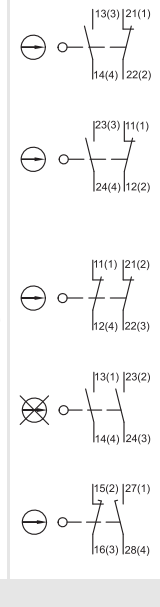
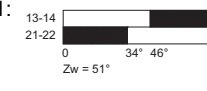
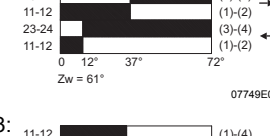
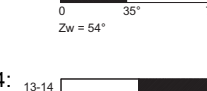
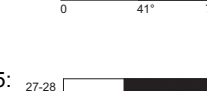
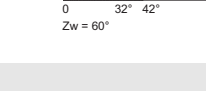
Actuator	Operation	Diagram	Nominal contact travels or angles	Minimum force/torque
Type 7070/1	<p>V = Max. operating speed                      → = Direction of operation                      () = Connection for device with un-connected cable end</p>	<p>⊖ = Positive opening</p>	<p>■ = Contact closed                      □ = Contact open                      Zw = Travel for positive opening</p>	
Swivelling roller lever, form A 7070/1- . - HR311..	 <p>V = 1.8 m/s</p>		<p><b>7070/1-1:</b></p>  <p><b>7070/1-2:</b></p>  <p><b>7070/1-3:</b></p>  <p><b>7070/1-4:</b></p>  <p><b>7070/1-5:</b></p> 	<p>HR311: 0.3 Nm</p> <p>HR311N R: 0.1 Nm</p>
Adjustable roller lever 7070/1- . -HV	 <p>V = 1.4 m/s</p> <p>Should the adjustable roller lever swing back from an angle exceeding 40°, the lever could cause a false signal.</p>		<p><b>7070/1-1:</b></p>  <p><b>7070/1-2:</b></p>  <p><b>7070/1-3:</b></p>  <p><b>7070/1-4:</b></p>  <p><b>7070/1-5:</b></p> 	<p>0.3 Nm</p>

# Position Switches

## Series 7070



### Operation, Operating Speed, Contact Travel or Angle

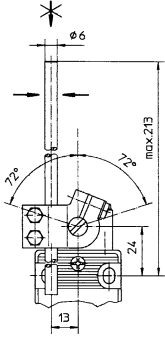
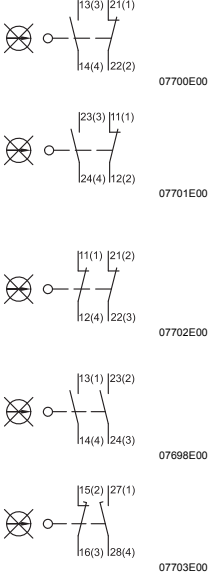
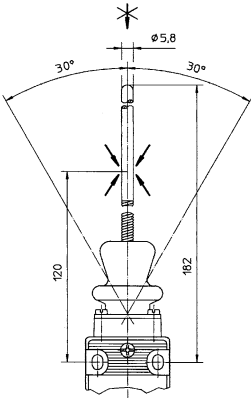
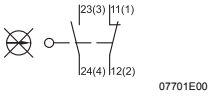

Actuator	Operation	Diagram	Nominal contact travels or angles	Minimum force/torque
Type 7070/1	<p>V = Max. operating speed                      → = Direction of operation                      () = Connection for device witch un-connected cable end</p>	<p>⊕ = Positive opening</p>	<p>■ = Contact closed                      □ = Contact open                      Zw = Travel for positive opening</p>	
Actuating rod 7070/1- . - HH-K	 <p>V = 1.4 m/s</p> <p>No positive opening, not suitable for safety circuits</p>		<p><b>7070/1-1:</b> 13-14 (3)-(4) / 21-22 (1)-(2) / 0 34° 46° 72° 07736E00</p> <p><b>7070/1-2:</b> 23-24 (3)-(4) / 11-12 (1)-(2) / 23-24 (3)-(4) / 11-12 (1)-(2) / 0 12° 37° 72° Zw = 61° 07749E00</p> <p><b>7070/1-3:</b> 11-12 (1)-(4) / 21-22 (2)-(3) / 0 35° 72° 07748E00</p> <p><b>7070/1-4:</b> 13-14 (1)-(4) / 23-24 (2)-(3) / 0 41° 72° 07747E00</p> <p><b>7070/1-5:</b> 27-28 (1)-(4) / 15-16 (2)-(3) / 0 32° 42° 72° 07737E00</p>	0.3 Nm
Spring-rod actuator 7070/1-2-F2	 <p>No positive opening, not suitable for safety circuits</p>		<p><b>Only for use with snap-action contact!</b> --</p> <p><b>7070/1-2:</b> 23-24 (3)-(4) / 11-12 (1)-(2) / 23-24 (3)-(4) / 11-12 (1)-(2) / 0 4° 14° 30° 07753E00</p>	--

E4

# Position Switches

## Series 7070

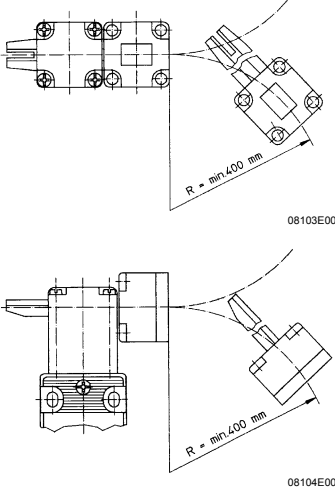
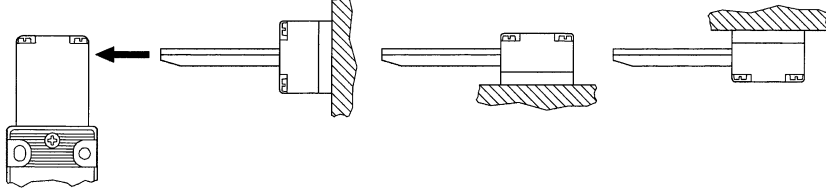
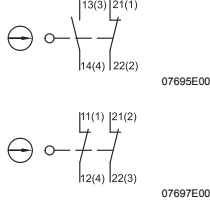
### Operation, Operating Speed, Contact Travel or Angle

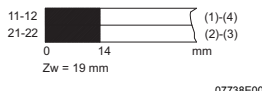
Actuator	Operation	Diagram	Nominal contact travels or angles	Minimum force/torque
Type 7070/1	<p>V = Max. operating speed                      → = Direction of operation                      () = Connection for device with un-connected cable end</p>	<p>⊖ = Positive opening</p>	<p>■ = Contact closed                      □ = Contact open                      Zw = Travel for positive opening</p>	
Safety switch with separate actuator 7070/1- . -ZB	 <p>Do not use the switch as a mechanical stop.</p>  <p>The actuators can be mounted in several ways, this substantially increases the range of application of the switches.</p>		<p><b>7070/1-1:</b></p>  <p><b>7070/1-3:</b></p> 	--

### Accessories and Spare Parts

Designation	Illustration	Description	Order number	Weight	
Actuating head		Extended plunger	8070/1-0-S	131805	0.044
		Roller plunger	8070/1-0-RS	131809	0.042
		Roller lever, form E (can be modified into an angled roller lever)	8070/1-0-AR	131812	0.046
		Swivelling roller lever, form A	8070/1-0-HR311	131815	0.099
		Swivelling roller lever, form A (swivelling lever of stainless steel)	8070/1-0-HR311NR	131841	0.099





# Position Switches

## Series 7070

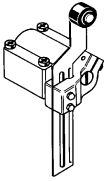
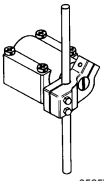
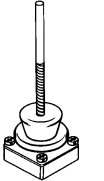

### Accessories and Spare Parts

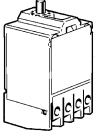
Designation	Illustration	Description	Order number	Weight	
Actuating head		Adjustable roller lever	8070/1-0-HV	<b>131818</b>	0.148
		Actuating rod	8070/1-0-HH-K	<b>131821</b>	0.162
		Spring-rod actuator <b>Only for use with snap-action contact!</b>	8070/1-0-F2	<b>131824</b>	0.059
		Safety switch with separate actuator (safety operating head)	8070/1-0-ZB	<b>131832</b>	0.071
		Safety switch with separate actuator (actuating element)	8070/1-0-ZB	<b>131835</b>	0.039
Cable gland		8161/5-M20-13	1 piece	<b>138518</b>	0.012
Contact block		1 NC + 1 NO Slow-action contact	G080/1-1	<b>132541</b>	0.025
		2 NC Slow-action contact	G080/1-3	<b>132544</b>	0.025
		2 NO Slow-action contact	G080/1-4	<b>132545</b>	0.025
		1 NC + 1 NO Slow-action contact, make before break	G080/1-5	<b>132546</b>	0.025
		1 NC + 1 NO Snap-action contact, with spring	G080/1-2	<b>132542</b>	0.025

E4

### Dimensional Drawings (All Dimensions in mm) - Subject to Alterations

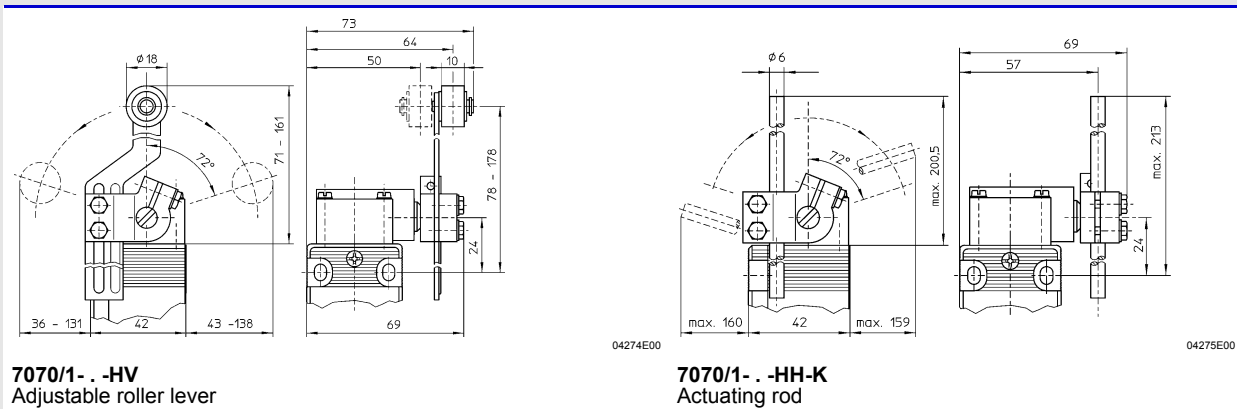

# Position Switches

## Series 7070

**Dimensional Drawings** (All Dimensions in mm) - Subject to Alterations

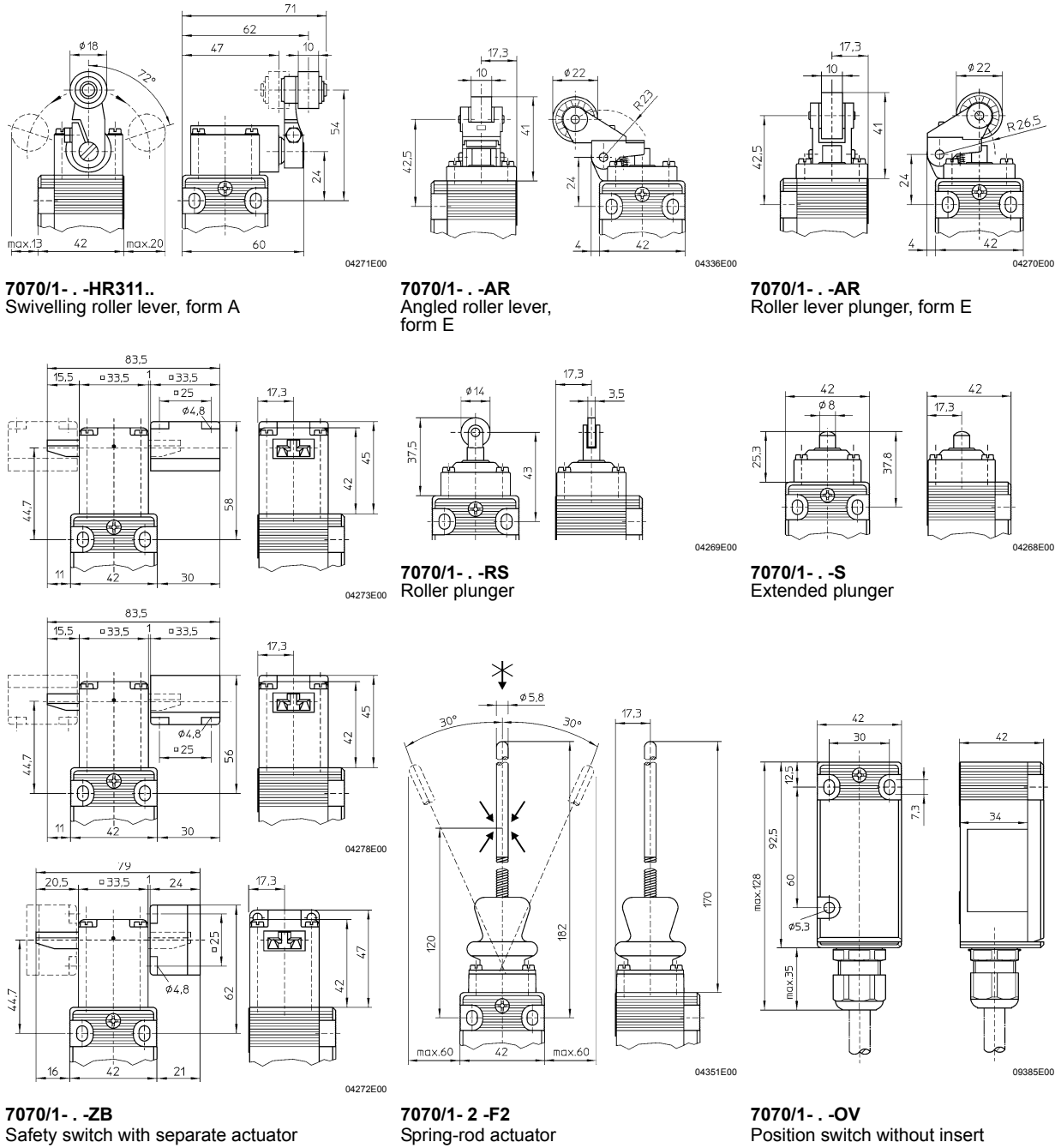

We reserve the right to make alterations to the technical data, weights, dimensions, designs and products available without notice. The illustrations cannot be considered binding.