

Control Unit Series 8208

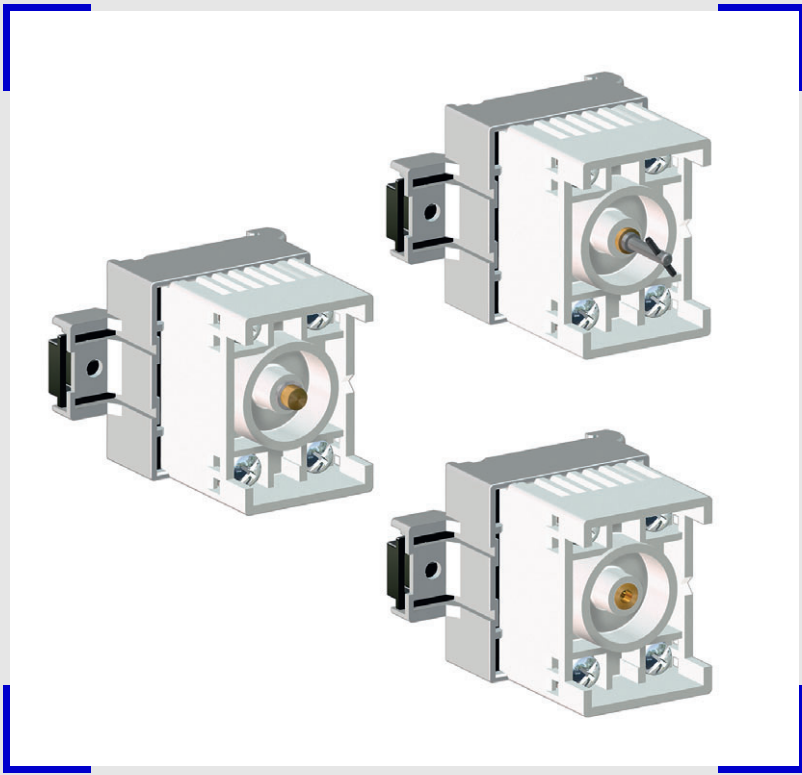

www.stahl.de



- > Installation of various components such as
 - Snap action switch
 - Potentiometer
 - Relay
 - Time relay
 - Diodes
 - Fuses
 - Resistors



01776E00

E4

Components of various functions such as diodes, resistors, fuses and relays are integrated in the Ex d enclosure 8208. The shown functions are standardised, other customer orders are available on request.

	ATEX / IECEx						Zone	NEC 505 Class I			NEC 506			Division	NEC 500							
	0	1	2	20	21	22		0	1	2	20	21	22		1	2	1	2	1	2		
For use		x	x		x	x	For use in		x ^{*)}	x ^{*)}		x ^{*)}	x ^{*)}	For use in		x ^{*)}						

^{*)} Canada

WebCode 8208A

Control Unit

Series 8208

Selection Table

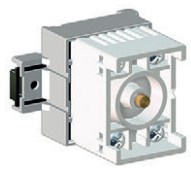
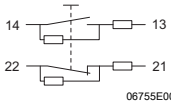
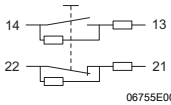
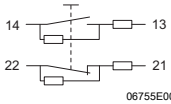
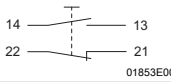
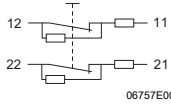
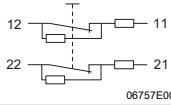
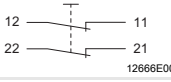
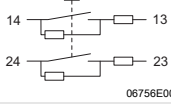
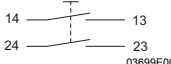
Version	Description	Resistance values	Schematic	Order number	Weight kg	
 <p>Snap switch Series 8208</p> <p>11042E00</p>	with open-circuit and short-circuit detection	1 NO / 1 NC, positive opening	10 k Ω / 1 k Ω	 <p>06755E00</p>	8208 / 24-15-0001	0.100
		1 NO / 1 NC	10 k Ω / 1.8 k Ω	 <p>06755E00</p>	8208 / 24-15-0011	0.117
		1 NO / 1 NC	22.1 k Ω / 681 Ω	 <p>06755E00</p>	8208 / 24-15-0021	0.100
		1 NO / 1 NC	--	 <p>01853E00</p>	8208 / 24-15-0051	0.100
		2 NC, positive opening	10 k Ω / 1 k Ω	 <p>06757E00</p>	8208 / 24-15-0002	0.100
		2 NC	10 k Ω / 1.8 k Ω	 <p>06757E00</p>	8208 / 24-15-0012	0.065
		2 NC	--	 <p>12666E00</p>	8208 / 24-15-0052	0.065
		2 NO	10 k Ω / 1 k Ω	 <p>06756E00</p>	8208 / 24-15-0003	0.100
		2 NO	--	 <p>03699E00</p>	8208 / 24-15-0053	0.100

Note Other versions on request. For actuators see control buttons Series 8082

Explosion Protection

Global (IECEX)

Gas and mining	IECEX PTB 06.0032U Ex d e IIC Gb Ex d e I Mb
----------------	--

Europe (ATEX)

Gas and mining	PTB 01 ATEX 1066 U  II 2 G Ex d e IIC Gb  I M 2 Ex d e I Mb
----------------	---

Certifications and certificates

Certificates	IECEX, ATEX, Brazil (INMETRO), India (PESO), Canada (CSA), Serbia (SRPS)
--------------	--

Technical Data

Contact block

Electrical data	
Rated operational current	AC-15: 1.5 A DC-13: 0.5 A
Rated operational voltage	AC-15: 230 V DC-13: 60 V
Contact resistance	typical 10 m Ω
Mechanical data	
Contact material	gold

Technical Data

Resistors

Ambient conditions	-60 ... +60 °C see table „Max. power“	
Ambient temperature at temperature class		
Max. power	Maximum internal heat distribution (Connection to 1.5 mm ² conductor cross-section and maximum 5 A)	
	Ambient temperature max. 40 °C	Ambient temperature max. 60 °C
	T _{surface} = max. 80 °C	T _{surface} = max. 80 °C
	2.0 W	1.0 W
Mechanical data		
Enclosure material	Polyamide	
Connection type	2.5 mm ² finely stranded (screw terminals)	

Dimensional Drawings (All Dimensions in mm [inches]) - Subject to Alterations

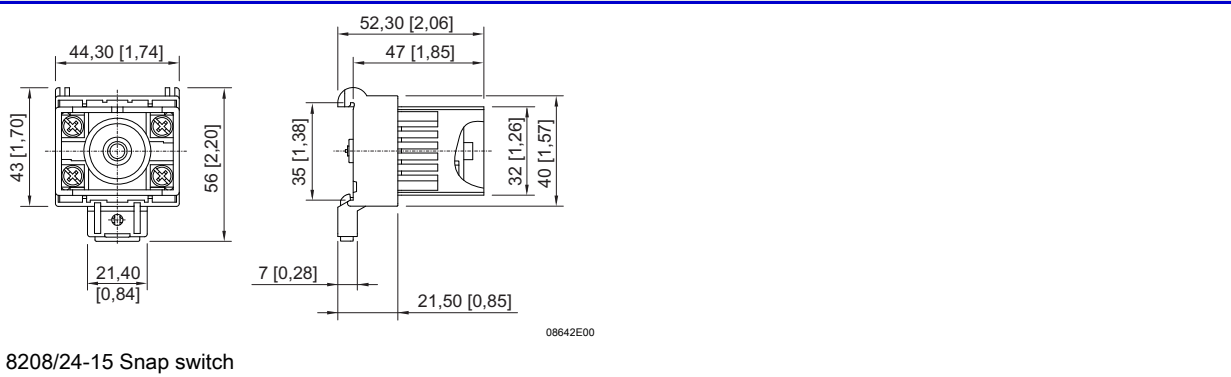

Control Unit

Series 8208

Selection Table

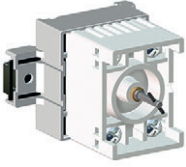
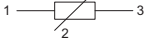
Version	Schematic	Resistance values	Order number	Weight kg
 <p>Potentiometer Series 8208</p> <p>10028E00</p>	 <p>09845E00</p>	1 k Ω	8208/24-08-01k0	0.090
		4.7 k Ω	8208/24-08-04k7	0.090
		10 k Ω	8208/24-08-010k	0.090
		Resistance values see order number supplement	8208/24-08-	0.090

Order Number Supplement

Other resistance values for 8208/24-08-....	100 Ω 100 k Ω 1M Ω 220 Ω 2.2 k Ω 22 k Ω 220 k Ω 47 k Ω 470 k Ω	8208/24-08-0K10 8208/24-08-0M10 8208/24-08-01M0 8208/24-08-0K22 8208/24-08-02K2 8208/24-08-022K 8208/24-08-0M22 8208/24-08-047K 8208/24-08-0M47	
Example: Potentiometer with resistance value 100 Ω :		8208/24-08-0K10	

Selection Table

Version	Assembly	Description	Order number	Weight kg
 <p>Actuators Series 8602A</p> <p>04496E00</p>	8602A0092-1-006	with scale: 0 - 6	8602A0092-1-006	0.030
	8602A0092-1-010	with scale: 0 - 10	8602A0092-1-010	0.030
	8602A0092-1-100	with scale: 0 - 100	8602A0092-1-100	0.030

Note Other versions on request.

Explosion Protection

Global (IECEx)

Gas and mining	IECEx PTB 06.0032U Ex d e IIC Gb Ex d e I Mb
----------------	--

Europe (ATEX)

Gas and mining	PTB 01 ATEX 1066 U ⊕ II 2 G Ex d e IIC Gb ⊕ I M 2 Ex d e I Mb
----------------	---

Certifications and certificates

Certificates	IECEx, ATEX, Brazil (INMETRO), India (PESO), Canada (CSA), Serbia (SRPS)
--------------	--

Technical Data

Electrical data

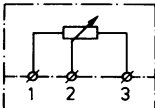
Rated insulation voltage	max. 500 V
Rated operational power	2 W
Resistance values	100 Ω ... 1 M Ω
Characteristic curve	linear
Resistance tolerance	± 20 %
Resistor material	Carbon composition
Circuit diagram	

Stop strength ≥ 100 Ncm

06065E00

Technical Data

Ambient conditions							
Ambient temperature at temperature class	-55 ... +60 °C see table „Max. power“						
Max. power	Maximum internal heat distribution (Connection to 1.5 mm ² conductor cross-section and maximum 5 A)						
	<table border="1"> <tr> <td>Ambient temperature max. 40 °C</td> <td>Ambient temperature max. 60 °C</td> </tr> <tr> <td>T_{surface} = max. 80 °C</td> <td>T_{surface} = max. 80 °C</td> </tr> <tr> <td>2.0 W</td> <td>1.0 W</td> </tr> </table>	Ambient temperature max. 40 °C	Ambient temperature max. 60 °C	T _{surface} = max. 80 °C	T _{surface} = max. 80 °C	2.0 W	1.0 W
Ambient temperature max. 40 °C	Ambient temperature max. 60 °C						
T _{surface} = max. 80 °C	T _{surface} = max. 80 °C						
2.0 W	1.0 W						

Mechanical data	
Enclosure material	Polyamide
Rotation range	270 °
Torque	0.7 ... 2 Ncm
Connection type	2.5 mm ² flexible

Note The switching capacity of the line side fuse of the potentiometer must be equal or larger than the maximum short circuit current (max. 3xI_B acc. to IEC 60127-2-1).

Dimensional Drawings (All Dimensions in mm [inches]) - Subject to Alterations

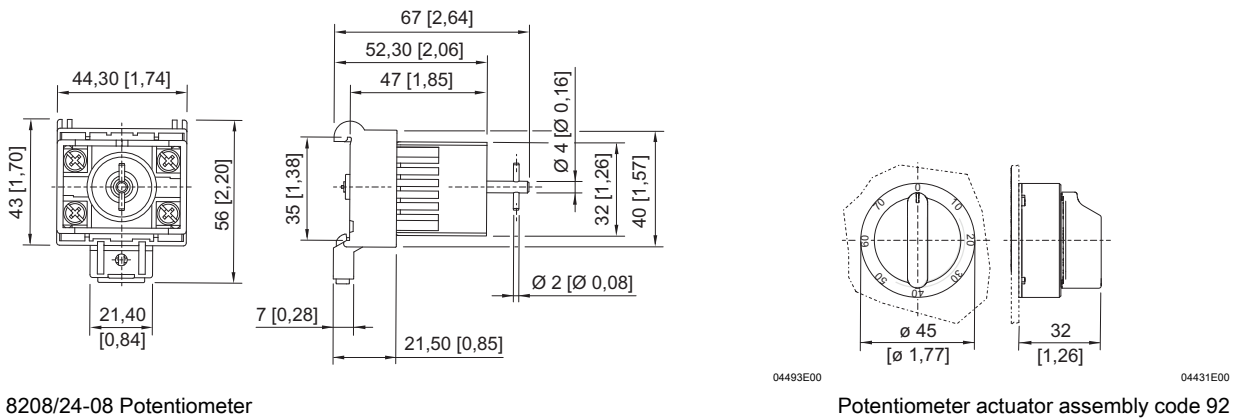

Control Unit

Series 8208

Selection Table

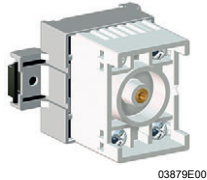
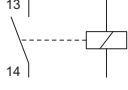
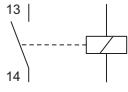
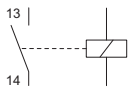
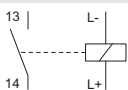
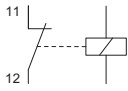
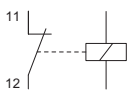
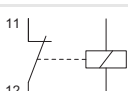
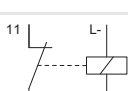
Version	Description	Rated operational voltage	Schematic	Order number	Weight kg
 <p>Relay Series 8208</p> <p>03879E00</p>	1 NO	24 V AC	 15131E00	8208 / 14-06-0010	0.090
		115 V AC	 15131E00	8208 / 14-06-0011	0.090
		230 V AC	 15131E00	8208 / 14-06-0012	0.090
		24 V DC	 01744E00	8208 / 14-06-0030	0.090
	1 NC	24 V AC	 09862E00	8208 / 14-06-0020	0.090
		115 V AC	 09862E00	8208 / 14-06-0021	0.090
		230 V AC	 09862E00	8208 / 14-06-0022	0.090
		24 V DC	 10865E00	8208 / 14-06-0040	0.090
Note	Other versions on request.				

Explosion Protection

Global (IECEX)

Gas and mining

IECEX PTB 06.0032U
Ex d e IIC Gb
Ex d e I Mb

Europe (ATEX)

Gas and mining

PTB 01 ATEX 1066 U
⊕ II 2 G Ex d e IIC Gb
⊕ I M 2 Ex d e I Mb

Certifications and certificates

Certificates

IECEX, ATEX, Brazil (INMETRO), India (PESO), Canada (CSA), Serbia (SRPS)

Technical Data

Electrical data

Rated operational current | 5 A

Ambient conditions

Ambient temperature at temperature class | -40 ... +60 °C see table „Max. power“

Max. power

Maximum internal heat distribution

(Connection to 1.5 mm² conductor cross-section and maximum 5 A)

Ambient temperature max. 40 °C

Ambient temperature max. 60 °C

T_{surface} = max. 80 °C

T_{surface} = max. 95 °C

T_{surface} = max. 80 °C

T_{surface} = max. 95 °C

3.0 W

4.75 W

1.5 W

2.0 W

Mechanical data

Enclosure material | Polyamide

Connection type | 2.5 mm² flexible

Dimensional Drawings (All Dimensions in mm [inches]) - Subject to Alterations

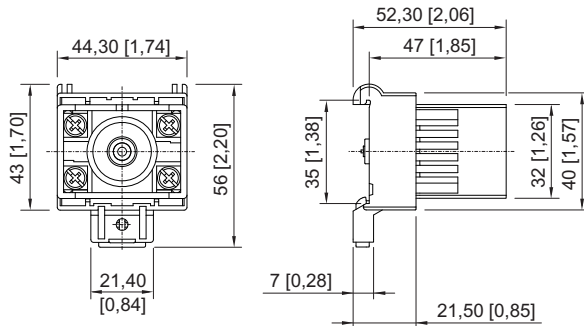

01877E00

8208/14-06 Relay

Control Unit

Series 8208

Selection Table

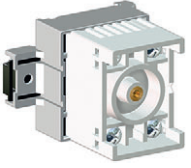
Version	Time domain	Rated operational voltage	Order number	Weight kg
 <p>Time relay Series 8208</p> <p>03879E00</p>	5 min	24 V AC	8208/14-14-0715-24V AC 5min	0.001
		120 V AC	8208/14-14-0715-120V AC 5min	0.077
		24 V DC	8208/14-14-0715-24V DC 5min	0.001
	15 min	230 V AC	8208/14-14-0715-230V AC 15min	0.075

Note Other versions on request.

Explosion Protection

Global (IECEX)

Gas and mining	IECEX PTB 06.0032U Ex d e IIC Gb Ex d e I Mb
----------------	--

Europe (ATEX)

Gas and mining	PTB 01 ATEX 1066 U ⊗ II 2 G Ex d e IIC Gb ⊗ I M 2 Ex d e I Mb
----------------	---

Certifications and certificates

Certificates	IECEX, ATEX, Brazil (INMETRO), India (PESO), Canada (CSA), Serbia (SRPS)
--------------	--

Technical Data

Electrical data

Rated operational current	5 A
---------------------------	-----

Ambient conditions

Ambient temperature at temperature class	-40 ... +60 °C see table „Max. power“
Max. power	

Maximum internal heat distribution

(Connection to 1.5 mm² conductor cross-section and maximum 5 A)

Ambient temperature max. 40 °C

Ambient temperature max. 60 °C

T_{surface} = max. 80 °C

T_{surface} = max. 95 °C

T_{surface} = max. 80 °C

T_{surface} = max. 95 °C

3.0 W

4.75 W

1.5 W

2.0 W

Mechanical data

Enclosure material	Polyamide
Connection type	2.5 mm ² flexible

Dimensional Drawings (All Dimensions in mm [inches]) - Subject to Alterations

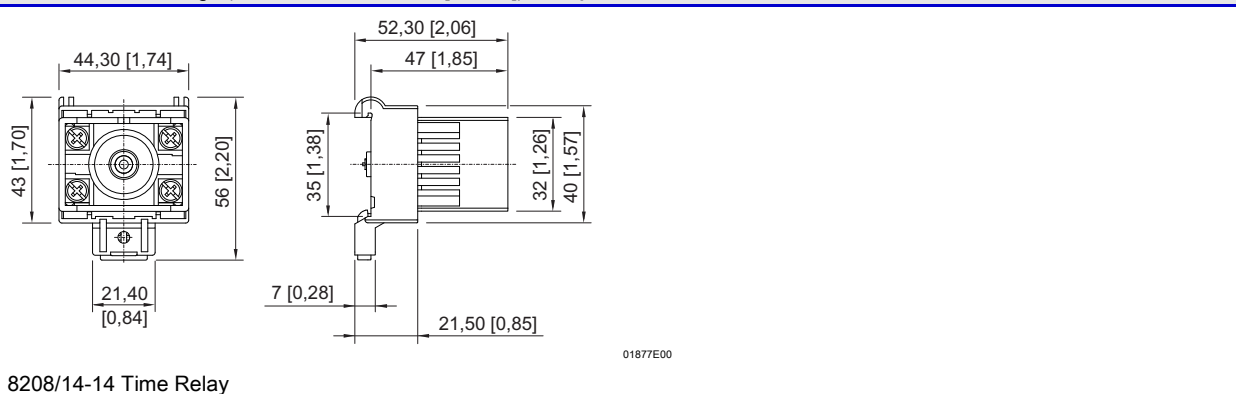

Selection Table

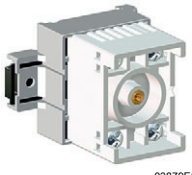
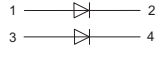
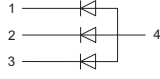
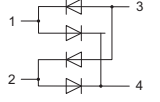
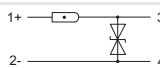
Version	Description	Schematic	Order number	Weight kg
 <p>Diode Series 8208</p> <p>03879E00</p>	2 diodes 1N4005	 <p>07637E00</p>	8208 / 14-02-0001	0.090
	3 diodes 1N4005	 <p>06053E00</p>	8208 / 14-02-0003	0.150
	4 diodes 1N4005	 <p>01667E00</p>	8208 / 14-02-0002	0.300
	Transient voltage suppression diode	 <p>10166E00</p>	8208 / 14-02-0050	0.071

Note Other versions on request.

Explosion Protection

Global (IECEX)

Gas and mining	IECEX PTB 06.0032U Ex d e IIC Gb Ex d e I Mb
----------------	--

Europe (ATEX)

Gas and mining	PTB 01 ATEX 1066 U ⊗ II 2 G Ex d e IIC Gb ⊗ I M 2 Ex d e I Mb
----------------	---

Certifications and certificates

Certificates	IECEX, ATEX, Brazil (INMETRO), India (PESO), Canada (CSA), Serbia (SRPS)
--------------	--

Technical Data

Electrical data

Rated operational voltage	500 V
Rated operational current	1 A

Ambient conditions

Ambient temperature at temperature class	-50 ... +60 °C see table „Max. power“
Max. power	

Maximum internal heat distribution

(Connection to 1.5 mm² conductor cross-section and maximum 5 A)

Ambient temperature max. 40 °C		Ambient temperature max. 60 °C	
T _{surface} = max. 80 °C	T _{surface} = max. 95 °C	T _{surface} = max. 80 °C	T _{surface} = max. 95 °C
3.0 W	4.75 W	1.5 W	2.0 W

Mechanical data

Enclosure material	Polyamide
Connection type	2.5 mm ² flexible

Dimensional Drawings (All Dimensions in mm [inches]) - Subject to Alterations

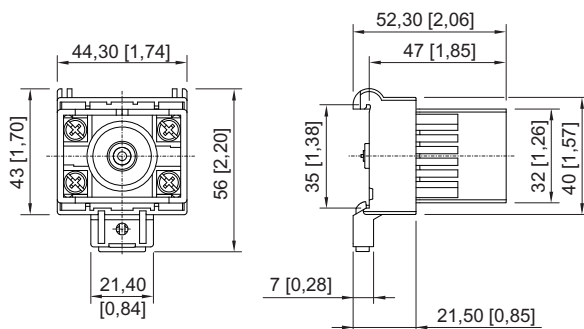

01877E00

8208/14-02 Diode

Control Unit Series 8208

Selection Table

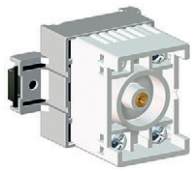
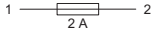
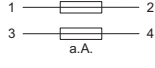
Version	Description	Schematic	Order number	Weight kg
 <small>03879E00</small> Fuse Series 8208	1 fuse	 <small>07638E00</small>	8208 / 14-12-0210	0.090
	2 fuses	 <small>06697E00</small>	8208 / 14-12-02.0	0.090

Note Other versions on request.

Explosion Protection

Global (IECEX)

Gas and mining	IECEX PTB 06.0032U Ex d e IIC Gb Ex d e I Mb
----------------	--

Europe (ATEX)

Gas and mining	PTB 01 ATEX 1066 U  II 2 G Ex d e IIC Gb  I M 2 Ex d e I Mb
----------------	---

Certifications and certificates

Certificates	IECEX, ATEX, Brazil (INMETRO), India (PESO), Canada (CSA), Serbia (SRPS)
--------------	--

Technical Data

Electrical data

Rated operational voltage	500 V AC
Max. breaking capacity	50 A AC

Ambient conditions

Ambient temperature at temperature class	-40 ... +60 °C see table „Max. power“
Max. power	

Maximum internal heat distribution

(Connection to 1.5 mm² conductor cross-section and maximum 5 A)

Ambient temperature max. 40 °C		Ambient temperature max. 60 °C	
T _{surface} = max. 80 °C	T _{surface} = max. 95 °C	T _{surface} = max. 80 °C	T _{surface} = max. 95 °C
3.0 W	4.75 W	1.5 W	2.0 W



Mechanical data

Enclosure material	Polyamide
Connection type	2.5 mm ²

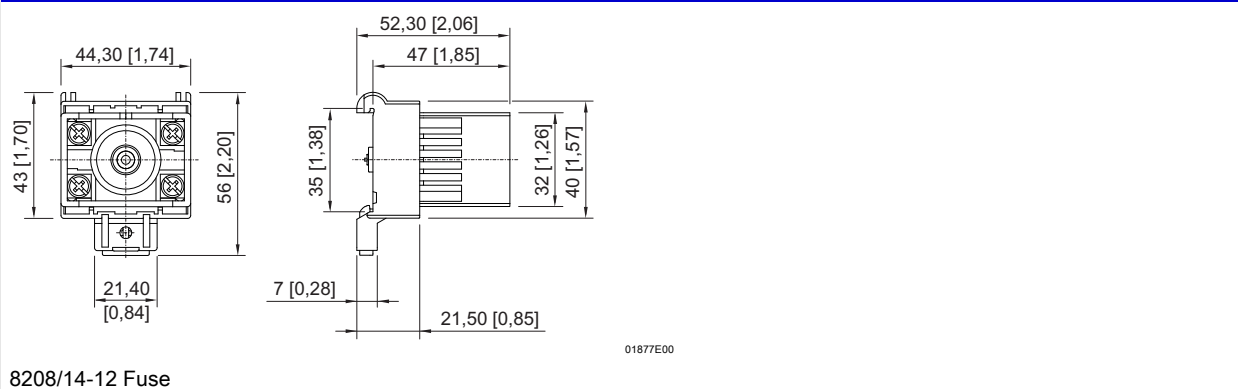
Dimensional Drawings (All Dimensions in mm [inches]) - Subject to Alterations

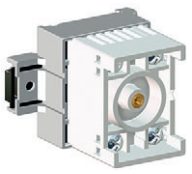

Selection Table

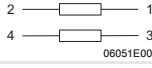
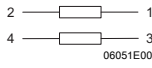
Version	Resistance values	Power	Rated operational voltage	Temperature class	Schematic	Order number	Weight kg
 Resistor Series 8208 <small>03879E00</small>	15 Ω ... 15 k Ω	1 x 2 W	max. 75 V	T5	 <small>06050E00</small>	8208/14-03-03.. 1 resistor 2W	0.090
	0.1 Ω ... 22 M Ω	2 x 0.5 W	max. 350 V	T6	 <small>06051E00</small>	8208/14-03-03.. 2 resist. 0,5W	0.090
	0.1 Ω ... 9.1 k Ω	2 x 1 W	max. 500 V	T6	 <small>06051E00</small>	8208/14-03-03.. 2 resistors 1W	0.090
Note		Other versions on request.					

Explosion Protection

Global (IECEX)

Gas and mining	IECEX PTB 06.0032U Ex d e IIC Gb Ex d e I Mb
----------------	--

Europe (ATEX)

Gas and mining	PTB 01 ATEX 1066 U II 2 G Ex d e IIC Gb I M 2 Ex d e I Mb
----------------	---

Certifications and certificates

Certificates	IECEX, ATEX, Brazil (INMETRO), India (PESO), Canada (CSA), Serbia (SRPS)
--------------	--

Technical Data

Electrical data

Rated operational voltage	max. 500 V
Resistance tolerance	± 10 %

Ambient conditions

Ambient temperature at temperature class	-55 ... +60 °C see table „Max. power“
Max. power	

Maximum internal heat distribution

(Connection to 1.5 mm² conductor cross-section and maximum 5 A)

Ambient temperature max. 40 °C		Ambient temperature max. 60 °C	
T _{surface} = max. 80 °C	T _{surface} = max. 95 °C	T _{surface} = max. 80 °C	T _{surface} = max. 95 °C
3.0 W	4.75 W	1.5 W	2.0 W

Mechanical data

Enclosure material	Polyamide
Resistor material	Metal film
Connection type	2.5 mm ² flexible

Dimensional Drawings (All Dimensions in mm [inches]) - Subject to Alterations

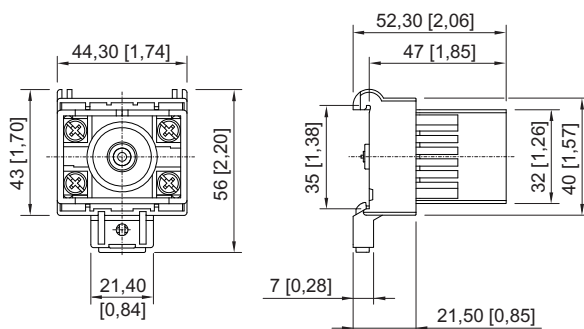

01877E00

8208/14-02 Diode

We reserve the right to make alterations to the technical data, dimensions, weights, designs and products available without notice. The illustrations cannot be considered binding.